

Rev.	001
Datum Date	21/09/2020

A-A (1 : 20)
Master

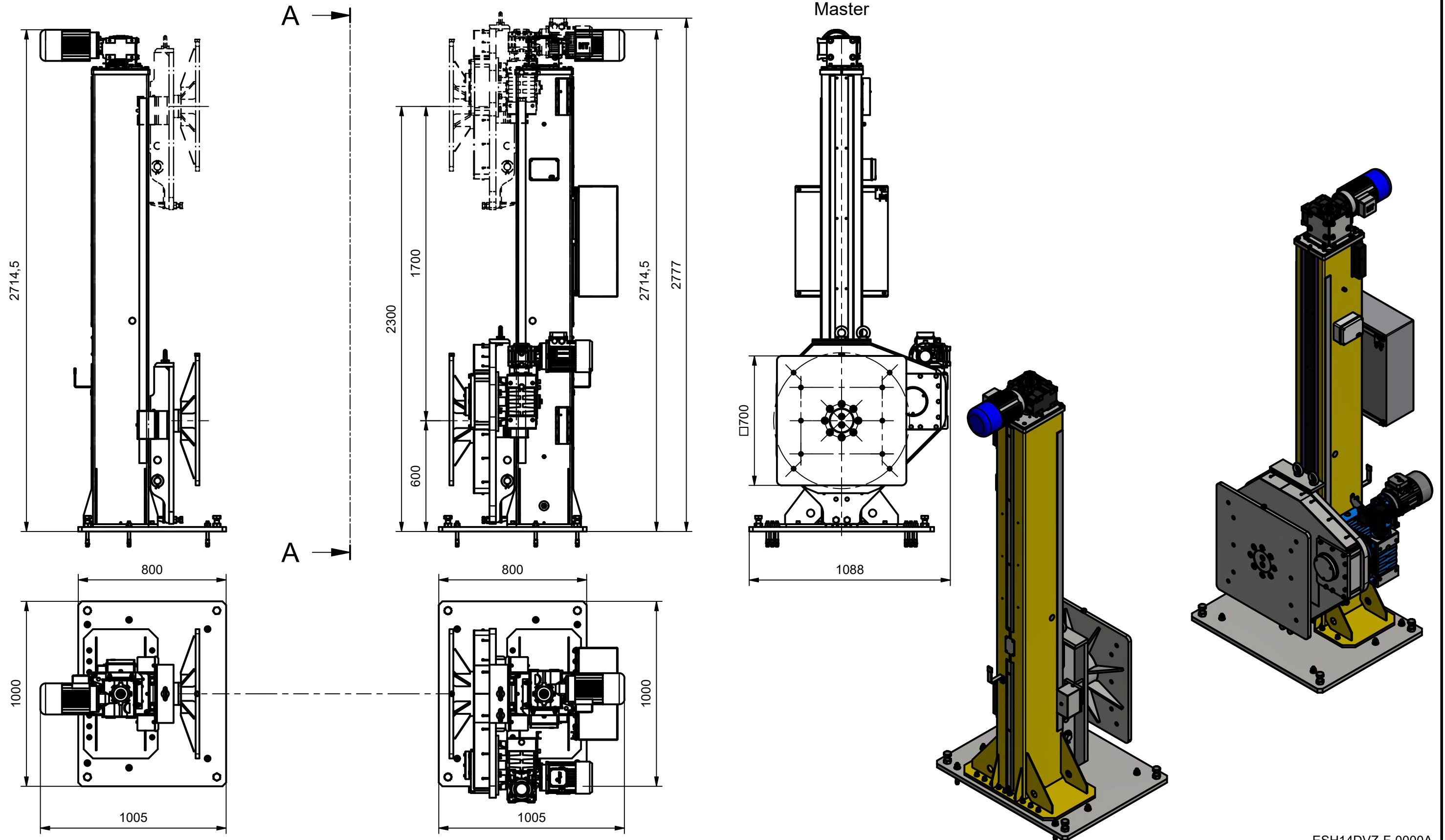

Rev.	001
Datum Date	21/09/2020

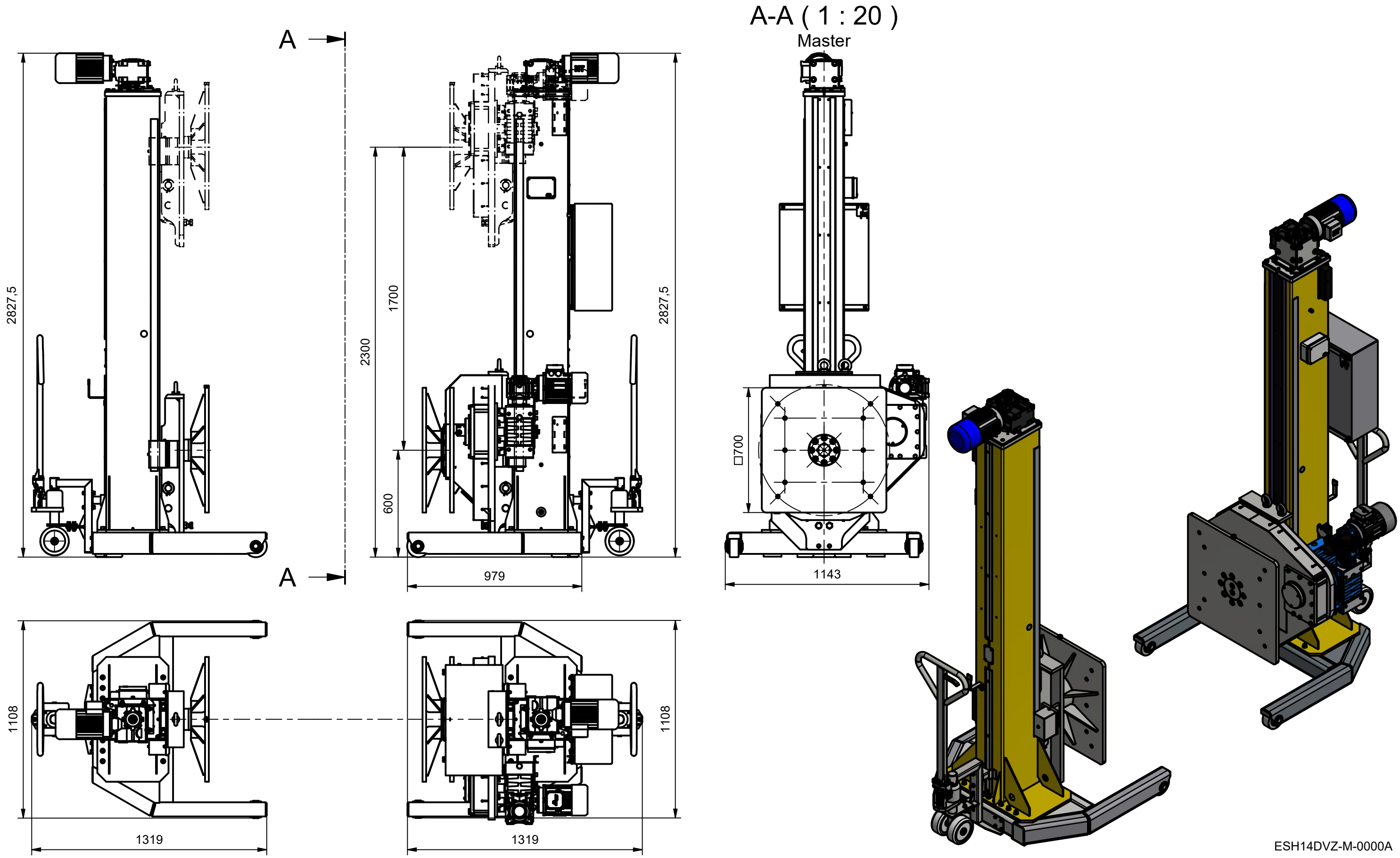

Standard flange plate
Standard Flanschplatte
Plaque à bride standard
(1 : 5)

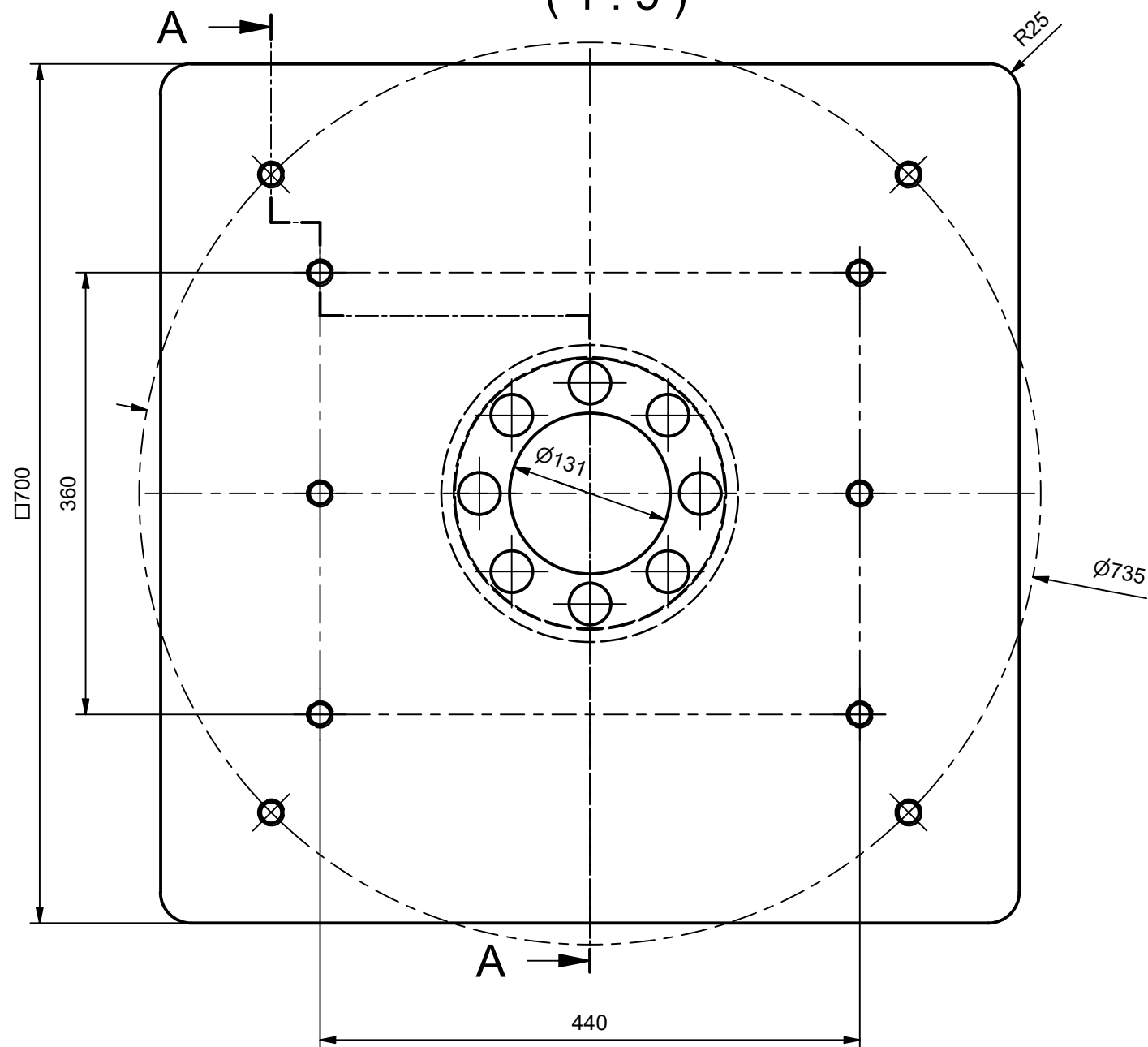

A-A (1 : 5)

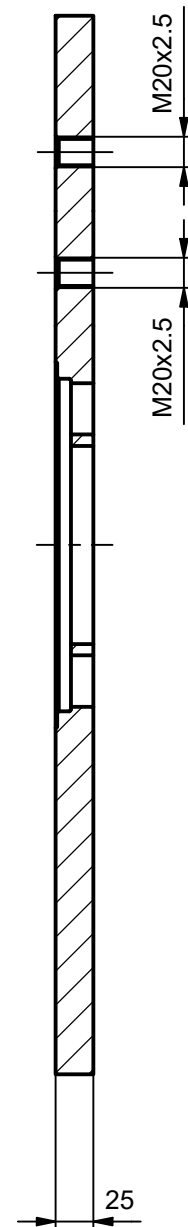

Leistungsdaten Performance data Caractéristiques	
DATA	WERT VALUE VALUER
Tragkraft Lifting capacity Capacité	2 x 7tons = 14tons
Drehmoment Turning moment Coupie de rotation	12.500Nm
Hubgeschwindigkeit Lifting speed Vitesse de levage	350mm/min
Drehgeschwindigkeit Turning speed Vitesse de rotation	0,42rpm
Benötigte Leistung Required power Puissance requise	2 x 2,2kW 3 x 400V / 50Hz

